

Wall plug

1 Kit content

- Hybrid cover
- Faceplate
- Wall plug tray
- Strain relief cover
- Cover screw
- Foam strip
- Tie-wrap

1.1 Accessories

- Fiber retainer
- Copper retainer
- Wall mounting screw kit
- 900 μm transportation tubing
- Overtubing
- Back plate
- Screws
- Loose tube fixation part

1.2 Cable preparation

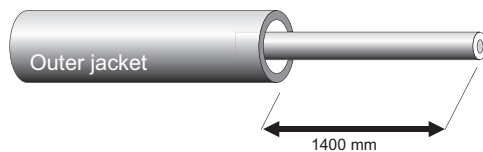

1.2.1 Remove the outer jacket over a distance of 1.4 m. Further cable preparation see § 1.2.5 till 1.2.6.

Insert box

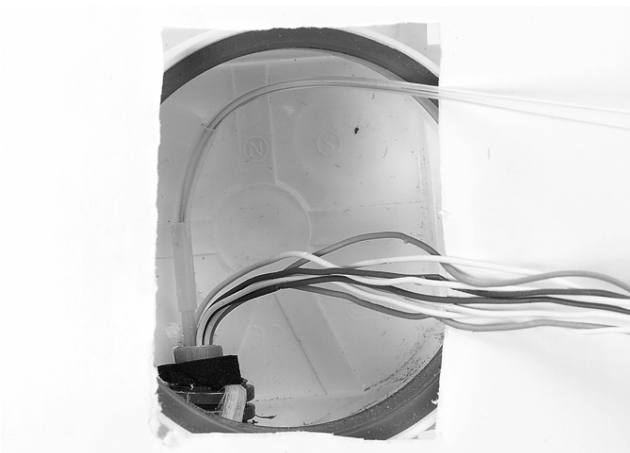

1.2.2 In case of an insert box, try to strip the outer jacket as close as possible to the entrance of the insert box.

Face plate



1.2.3 Mount the face plate onto the insert box using the appropriate holes. Guide the fibers and copper wires through the correct holes as shown in the picture.

Note: check the bending of the fibers in the insert box.

Face plate (no insert box, fiber only)

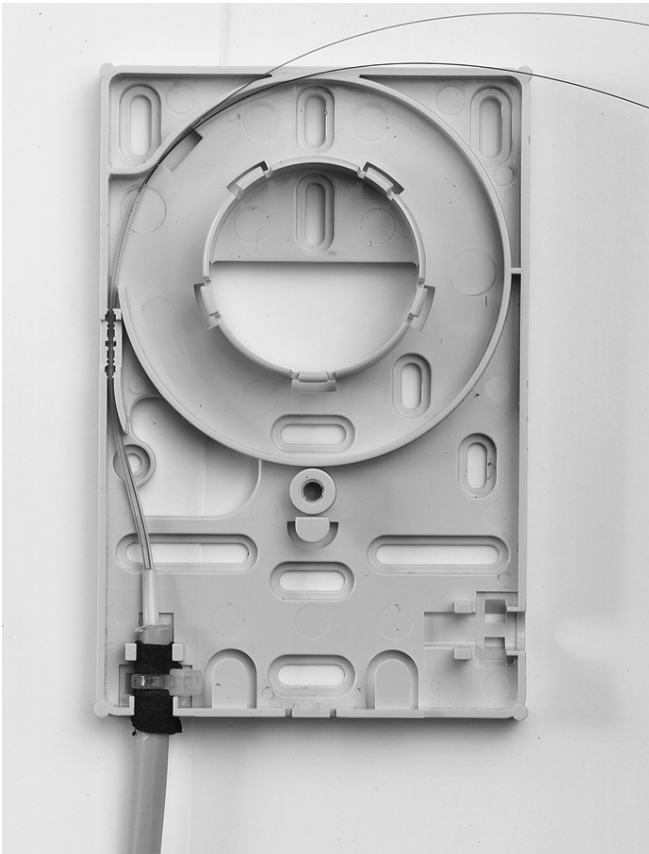
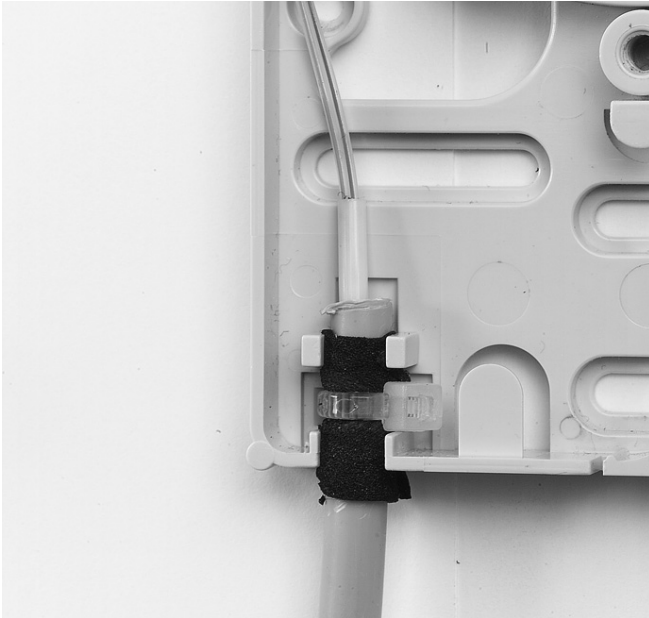

1.2.4 Feeder cable directly terminated onto the face plate (fiber only). Maximum cable diameter is 6 mm.

Strain relief

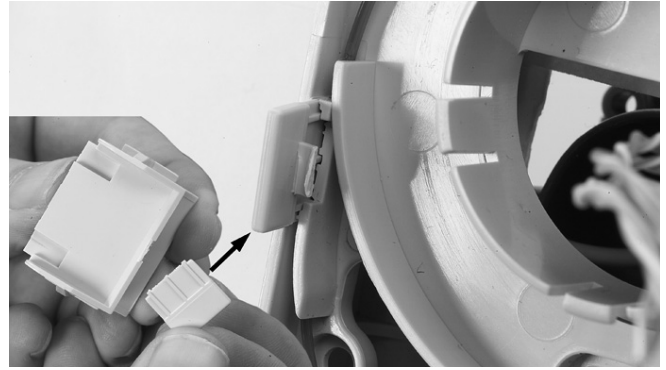

1.2.5 Secure the 900 μm fiber into the strain relief compartment by using the strain relief tool.

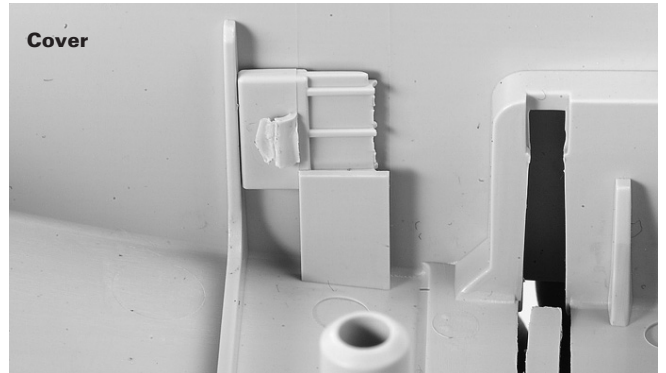

1.2.6 Place the strain relief tool inside the cover as shown.

Splicing: feeder cable to pigtail (max. 1 m, min. 0.65m)

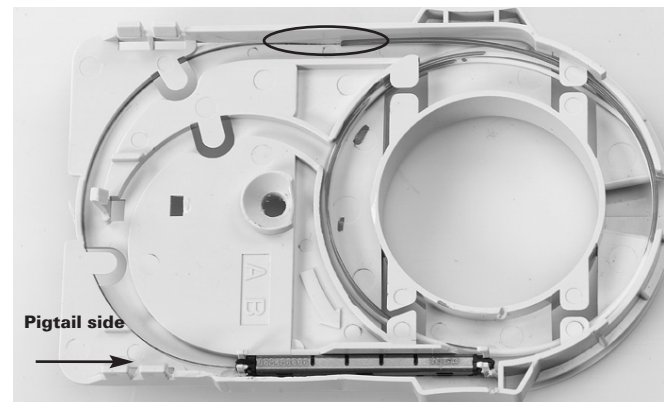
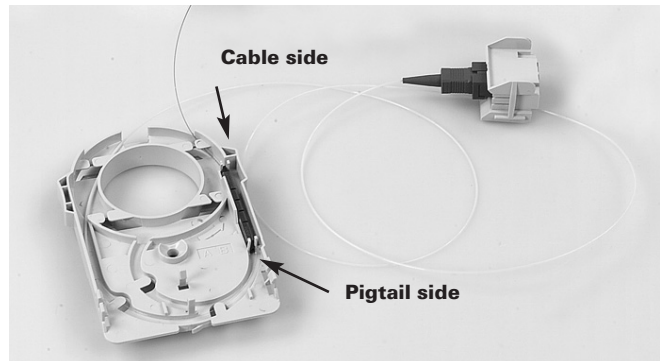

1.2.7 Strip the semi-tight pigtail for 160 mm and then splice to the feeder cable. Install the splice into the splice holder and route the pigtail side first. Transition of 250 μm to 900 μm should be positioned in this straight line.

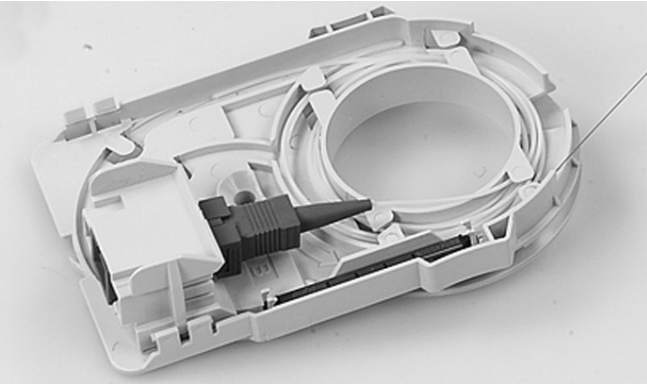
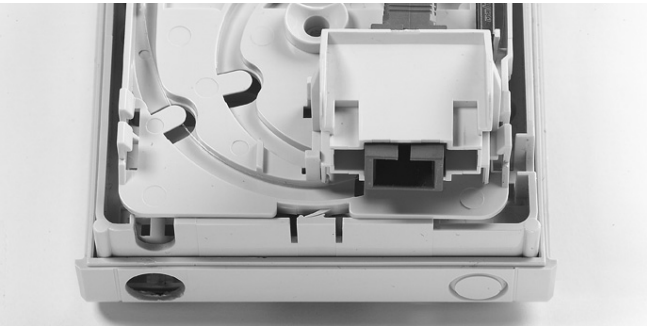

1.2.8 Install the retainer onto the tray. Route the fibers into the tray.

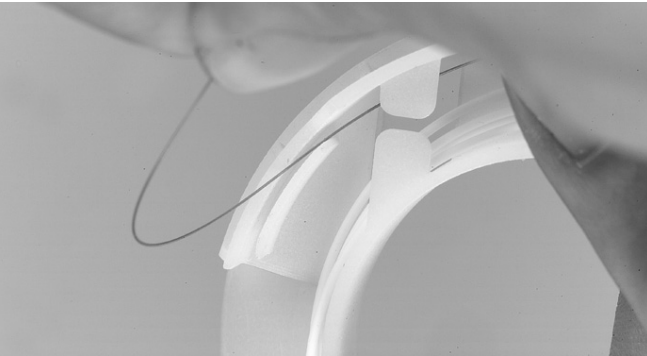

1.2.9 Route the feeder cable fibers to the backside of the tray as shown in the pictures.

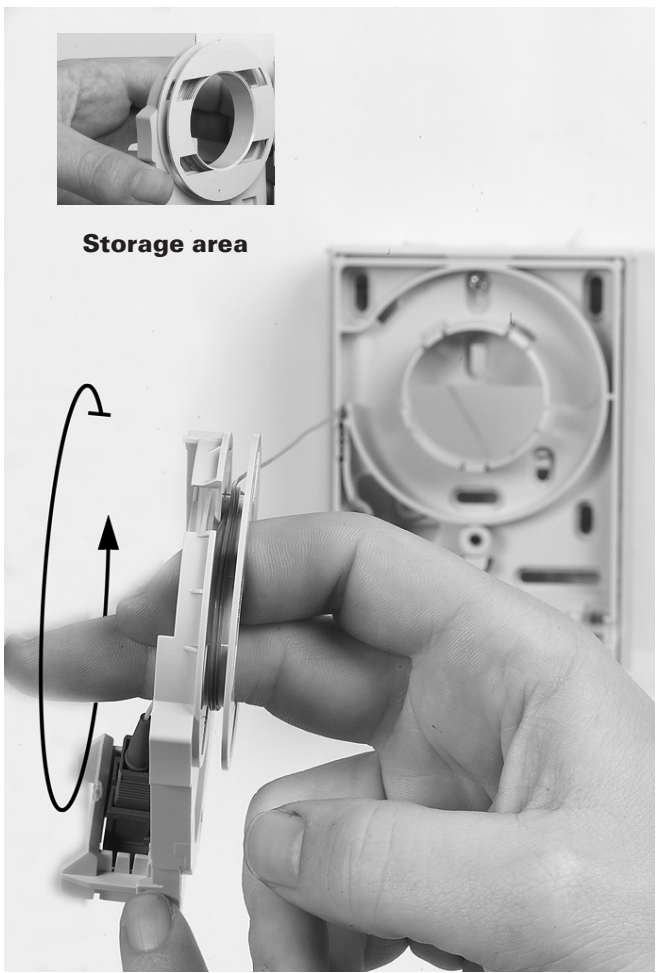

1.2.10 Rotate the tray towards the wall keeping the fibers under low tension so that fibers will be stored inside the storage area.

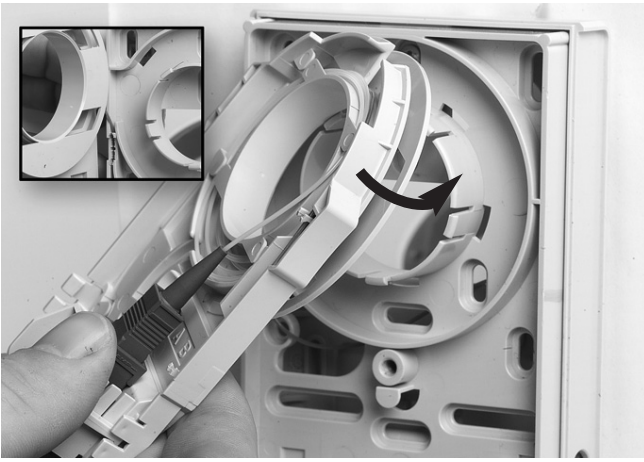

1.2.11 Rotate until the tray is touching the faceplate. Still keeping the fibers under low tension when installing the tray onto the face plate, so that fibers will stay inside the storage area during the installation.

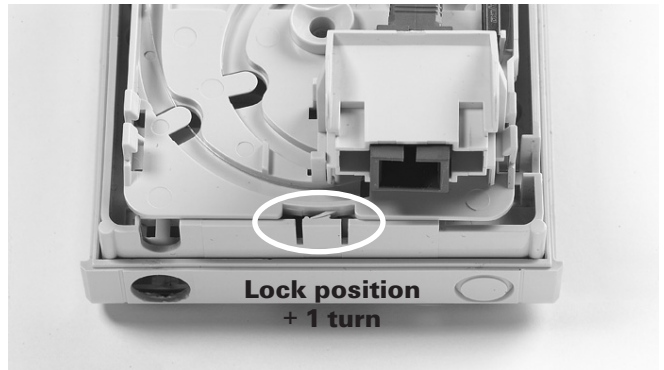
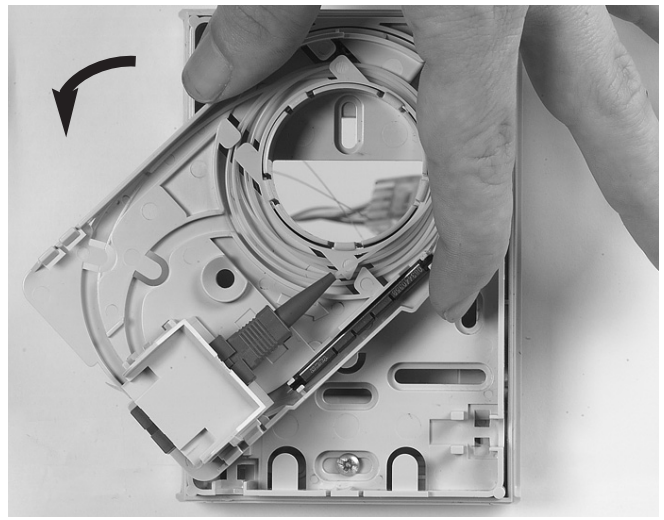

1.2.12 Turn the tray counter clockwise to the lock position and then 1 extra turn counter clockwise again to the lock position.
Note: do not turn clockwise !

Splicing: feeder cable to feeder cable

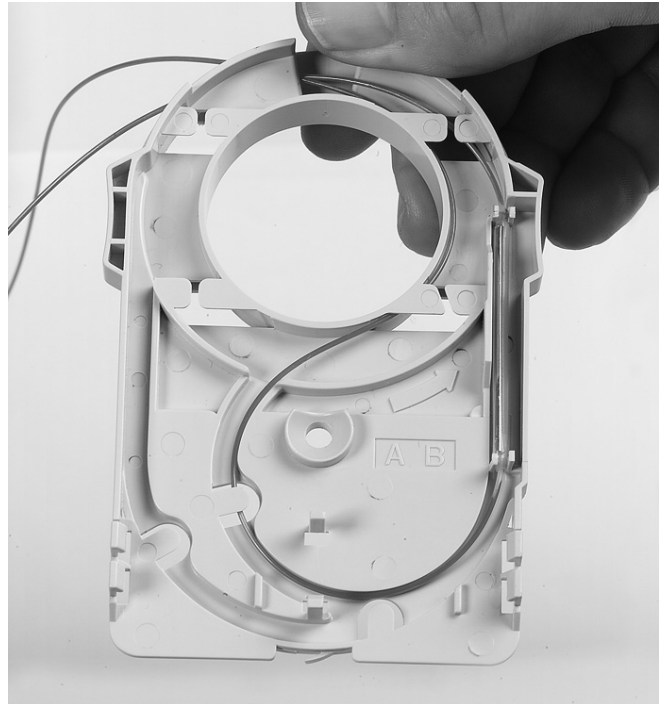

1.2.13 Routing inside the tray.

Copper termination

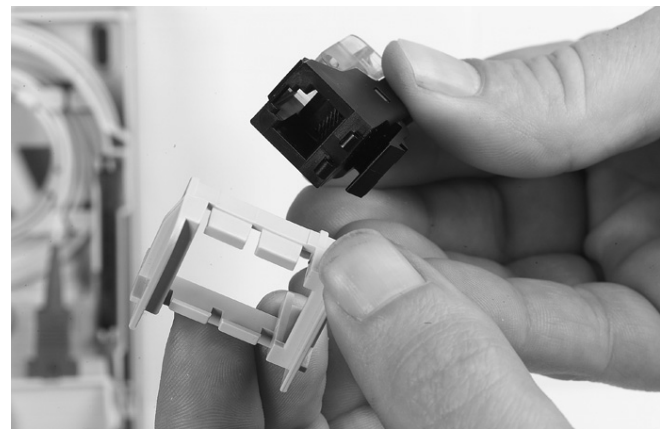
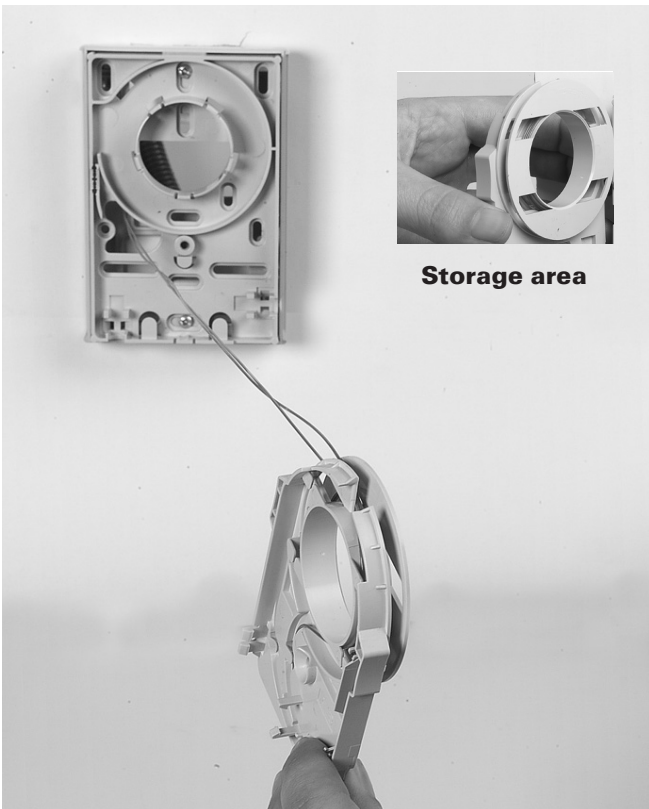
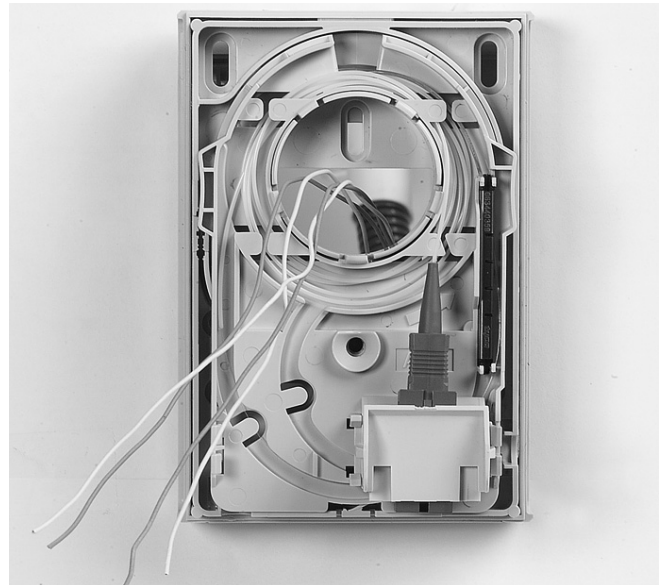
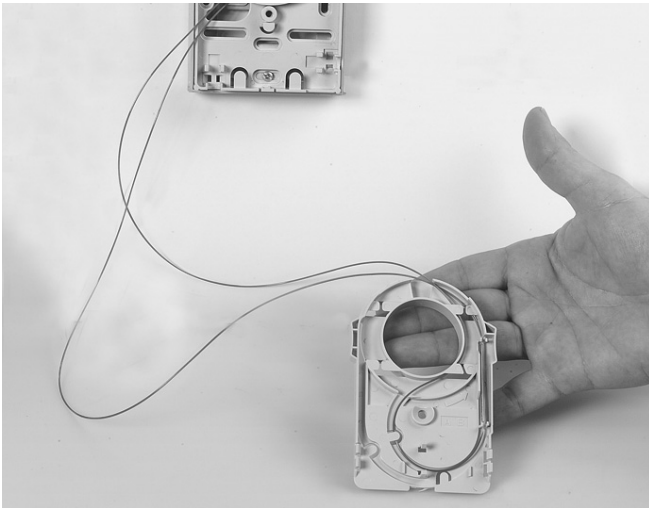

1.2.14 Make sure both fibers have the same length by routing already the longest fiber 1 turn inside the storage area. Secure and rotate both fibers, see paragraph **Strain relief** and 1.2.9 til 1.2.12.

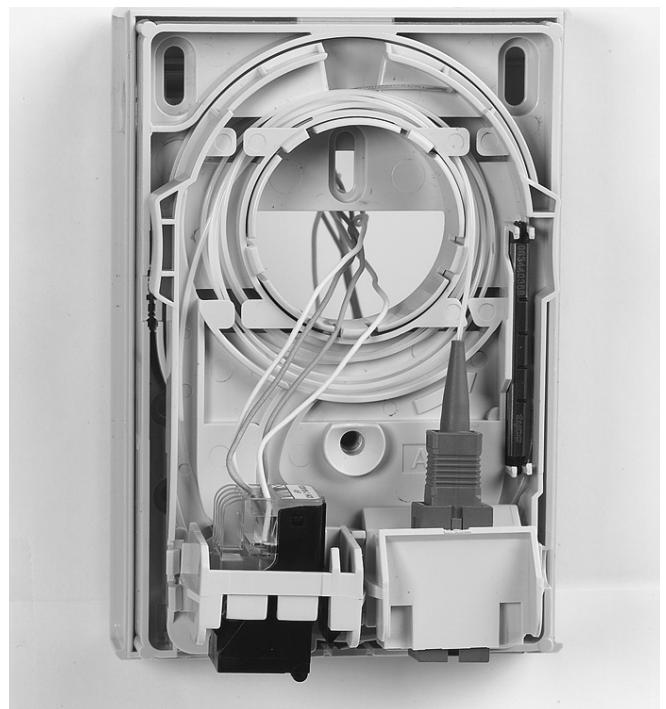

1.2.15 Terminate the copper wires and install the adapter into the copper retainer as shown and push the connector (RJ) into the retainer.



1.2.16 Termination of a CAT cable.

Tap-off

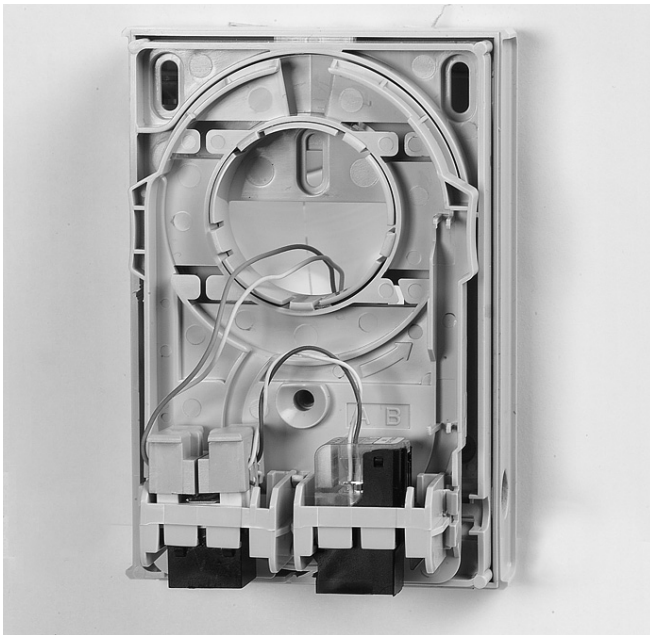

1.2.17 Using a copper retainer at both sides for connecting through.

Extension plate

Note: needed in case of:

- cable bigger then 6 mm
- hybrid cable routed onto the wall
- loose tube storage

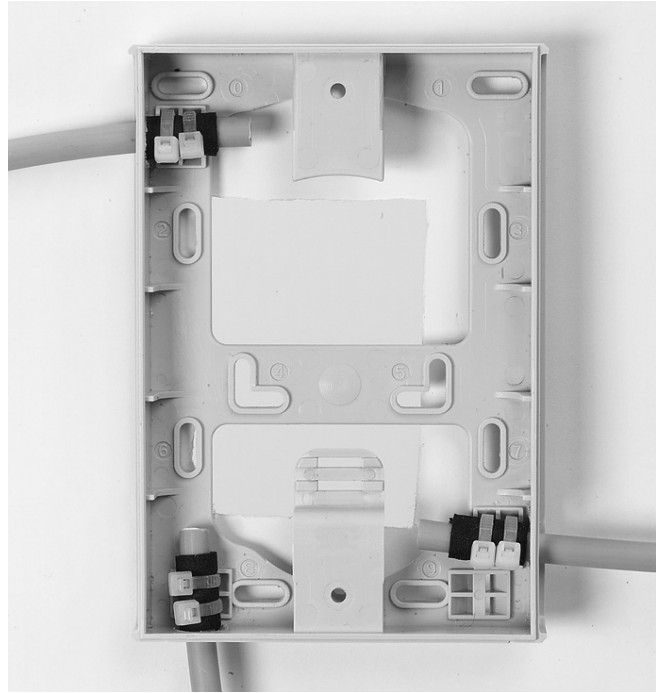

1.2.18 Possible entries when the cable is installed onto the wall. Max. cable diameter is 9 mm.

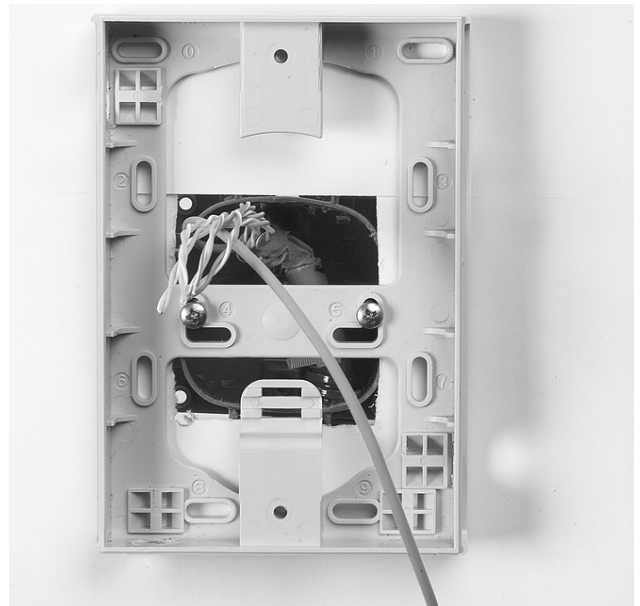

1.2.19 One of the many options to install the extension plate onto an insert box, using the appropriate holes



1.2.20 Hybrid cable: storage of loose tube, using copper wires only. Max. 1.4 m of loose tube storage (diam. 2.7 mm).

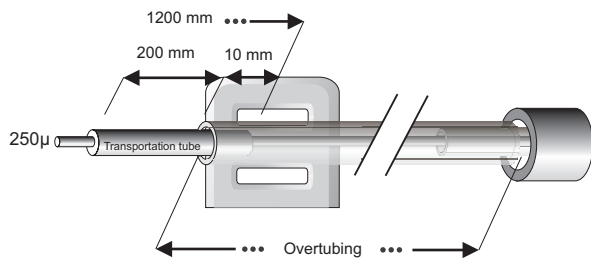
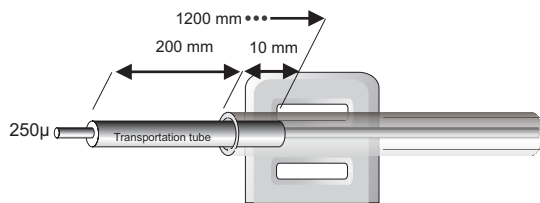
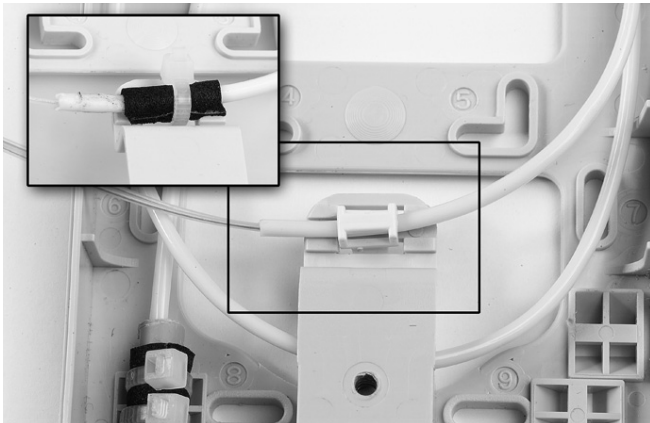

1.2.21 Route the loose tube to the tube holder, using the loose tube holder or tie wrap and foam for fixation. Depending the cable type choose further preparation with help of these drawings. Further installation: see paragraph **Strain relief**.

Closing the box



1.2.22 Install the cover onto the box.

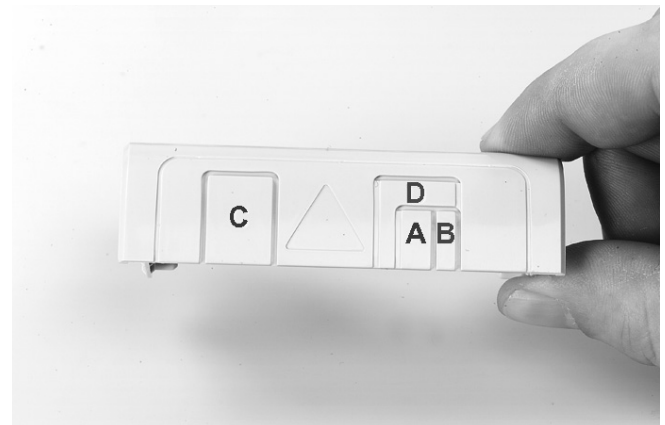

1.2.23 A & B for duplex LC connectors.
 A&B for SC connectors.
 B for Xpress drop
 C for RJ copper connections
 D for additional RJ copper connection.

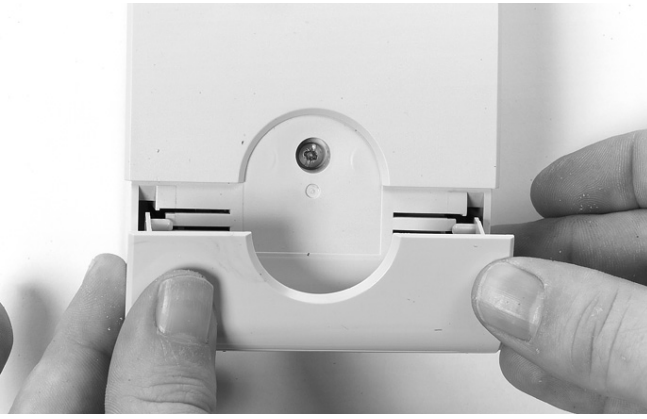

1.2.24 Installation of the strain relief cover. Seal the screw position with the label or other (local practice).

Tyco Electronics Raychem NV

Diestsesteenweg 692
B-3010 Kessel-Lo, Belgium
Tel.: 32-16-351 011
Fax: 32-16-351 697
www.tycoelectronics.com
www.telecomosp.com

Tyco Electronics and TE logo are trademarks

The information given herein, including drawings, illustrations and schematics which are intended for illustration purposes only, is believed to be reliable. However, Tyco Electronics makes no warranties as to its accuracy or completeness and disclaims any liability in connection with its use. Tyco Electronics' obligations shall only be as set forth in Tyco Electronics' Standard Terms and Conditions of Sale for this product and in no case will Tyco Electronics be liable for any incidental, indirect or consequential damages arising out of the sale, resale, use or misuse of the product. Users of Tyco Electronics products should make their own evaluation to determine the suitability of each such product for the specific application.